

SBM01/20 Board 1cells (3.6V/20A)

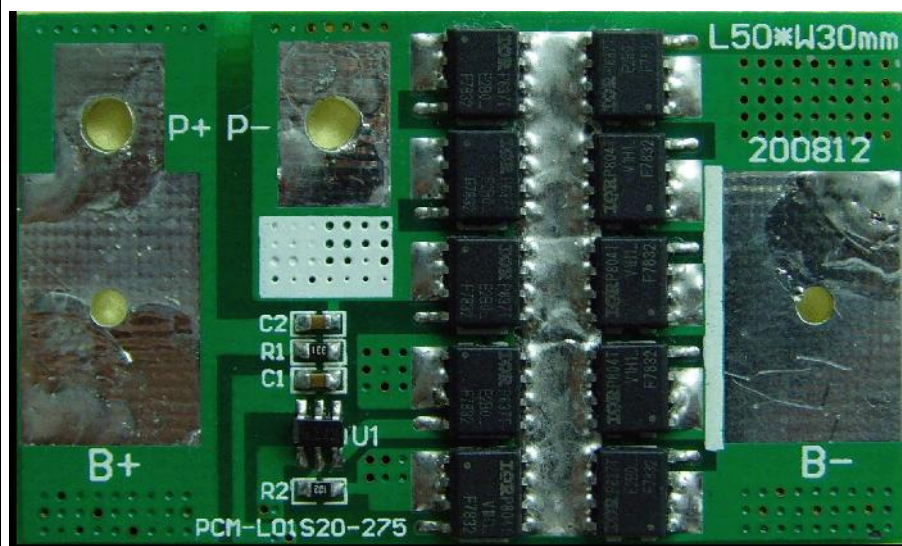

Model name	SBM 01/20	GWL/Power Simple Battery Management Board Single cell (3.6V/20A)
Voltage	Charging voltage	3.65V
	Balance voltage for single cell	No balancing capability
Current	Balance current for single cell	No balancing capability
	Current consumption	≤10μA
	Max. continuous current	20A (CHG and DCHG)
Overcharge Protection	Over charge detection voltage	3.90V±0.025V
	Over charge detection delay time	0.96S~1.4S
	Over charge release voltage	3.75±0.05V
Over-discharge Protection	Over discharge detection voltage	2.1±0.05V
	Over discharge detection delay time	115~173ms
	Over discharge release voltage	2.3±0.05V
Over Current Protection	Over current detection voltage	0.10±0.025V
	Over current detection current	25±3A
	Detection delay time	7.2ms~11ms
	Release condition	Cut load
Short Protection	Detection condition	Exterior short circuit
	Detection delay time	200-500μs
	Release condition	Cut load
Resistance	Protection circuitry	≤20mΩ
Temperature	Operating temperature range	-40~ +85°C
	Storage temperature range	-40 +125°C
Dimensions	L * W * T	50 * 30 * 3mm
Weight	6.5 g	Grams (tolerance +/- 2g)



Module wiring to the battery cells:

- Connect only to **1 piece of LiFePO4 cell**
- **B-** pin connect to the “-” terminal of the battery cell
- **B+** pin connect to the “+” terminal of the battery cell
- **P+ and P-** clamps connect to the appliance load

Please refer also to the overall scheme, according to the last page of this PDF document. In particular, it is necessary to install a fuse in the circuit. Please note that scheme is universal as possible example for installation, it is always necessary to carefully design a project. GWL Power Company is not responsible for the specific involvement.

SBM04/60 Board 4cells (12V/60A)



Model name	SBM 04/60	GWL/Power Simple Battery Management Board 4 cells (12V/60A)
Voltage	Charging voltage	C:14,4V 3.6V/Cell
	Balance voltage for single cell	3.6V±0.003V
Current	Balance current for single cell	72±10mA
	Current consumption for single cell	≤20µA
	Max. continuous current	60A
Overcharge Protection	Over charge detection voltage	3.90V±0.025V
	Over charge detection delay time	0.96S~1.4S
	Over charge release voltage	3.80±0.025V
Over-discharge Protection	Over discharge detection voltage	2.0±0.05V
	Over discharge detection delay time	115~173mS
	Over discharge release voltage	2.3±0.05V
Over Current Protection	Over current detection voltage	0.62V
	Over current detection current	200±30A
	Detection delay time	7.2ms~11ms
	Release condition	Automatic Recovery
Short Protection	Detection condition	Exterior short circuit
	Detection delay time	200-500µs
	Release condition	Automatic Recovery
Resistance	Protection circuitry	≤20mΩ
Temperature	Operating temperature range	-40 +85°C
	Storage temperature range	-40 +125°C
Dimensions	L * W * T	120 * 80 * 30mm
Weight	100g	Grams (tolerance +/- 2g)

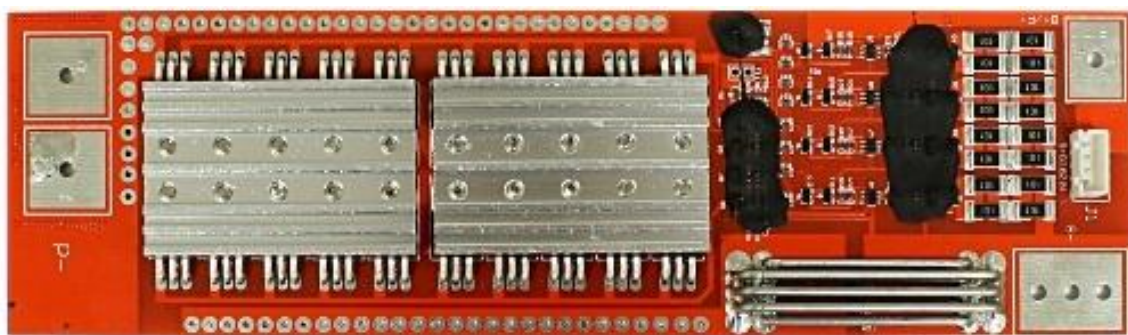

Module wiring to the battery cells:

- connect **4 pieces of LiFePO4 cells** in series
- **B-** clamp on the module connect to the “-” **terminal** of the first battery cell
- **B1** clamp connect to the “+” **terminal** of the same first battery cell
- **B2** clamp to the “+” **terminal** on the second cell
- **B3** clamp to the “+” **terminal** on the third cell
- **B4 and B+** clamps connected to the “+” **terminal** of the fourth cell. (two separate wires)
- **P+ and P-** clamps connect to the appliance **load**

Please refer also to the overall scheme, according to the last page of this PDF document.

In particular, it is necessary to install a fuse in the circuit. Please note that scheme is universal as possible example for installation, it is always necessary to carefully design a project.

GWL Power Company is not responsible for the specific involvement.

SBM04/10 Board 4cells (12V/10A)



Model name	SBM 04/10	GWL/Power Simple Battery Management Board 4 cells (12V/10A)
Voltage	Charging voltage	C:14,6V 3.6V/Cell
	Balance voltage for single cell	3.6V±0.025V
Current	Balance current for single cell	42±3mA
	Current consumption for single cell	≤50µA
	Max. continuous current	10A
Overcharge Protection	Over charge detection voltage	3.90V±0.025V
	Over charge detection delay time	0.5S~1.5S
	Over charge release voltage	3.80±0.05V
Over-discharge Protection	Over discharge detection voltage	2.0±0.05V
	Over discharge detection delay time	50~100ms
	Over discharge release voltage	2.3±0.05V
Over Current Protection	Over current detection voltage	0.62V
	Over current detection current	15±2A
	Detection delay time	5ms~15ms
	Release condition	Cut load
Short Protection	Detection condition	Exterior short circuit
	Detection delay time	200-500µs
	Release condition	Cut load
Resistance	Protection circuitry	≤30mΩ
Temperature	Operating temperature range	-40~ +85°C
	Storage temperature range	-40 +125°C
Dimensions	L * W * T	70 * 40 * 4mm
Weight	15g	Grams (tolerance +/- 2g)

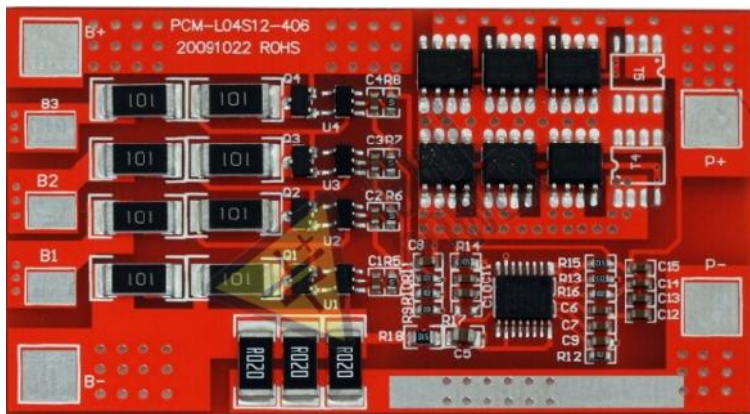

Module wiring to the battery cells:

- connect **4 pieces of LiFePO4 cells** in series
- **B-** clamp on the module connect to the “-” **terminal** of the first battery cell
- **B1** clamp connect to the “+” **terminal** of the same first battery cell
- **B2** clamp to the “+” **terminal** on the second cell
- **B3** clamp to the “+” **terminal** on the third cell
- **B+** clamp connected to the “+” **terminal** of the fourth cell.
- **P+ and P-** clamps connect to the appliance **load**

Please refer also to the overall scheme, according to the last page of this PDF document. In particular, it is necessary to install a fuse in the circuit. Please note that scheme is universal as possible example for installation, it is always necessary to carefully design a project. GWL Power Company is not responsible for the specific involvement.

SBM04/16H Board 4cells (12V/16A)



Model name	SBM 04/16H	GWL/Power Simple Battery Management Board 4 cells (12V/16A)
Voltage	Charging voltage	C:14,6V 3.6V/Cell
	Balance voltage for single cell	3.6V±0.025V
Current	Balance current for single cell	52±5mA
	Current consumption for single cell	≤50µA
	Max. continuous current	16A
Overcharge Protection	Over charge detection voltage	3.90V±0.025V
	Over charge detection delay time	0.5S~2S
	Over charge release voltage	3.80±0.05V
Over-discharge Protection	Over discharge detection voltage	2.0±0.08V
	Over discharge detection delay time	10~300ms
	Over discharge release voltage	2.5±0.1V
Over Current Protection	Over current detection voltage	0.15±0.025V
	Over current detection current	80±10A
	Detection delay time	5ms~20ms
	Release condition	Cut load
Short Protection	Detection condition	Exterior short circuit
	Detection delay time	200-500µs
	Release condition	Cut load
Resistance	Protection circuitry	≤50mΩ
Temperature	Operating temperature range	-40~ +85°C
	Storage temperature range	-40 +125°C
Dimensions	L * W * T	125 * 47 * 9 mm
Weight	80g	Grams (tolerance +/- 2g)

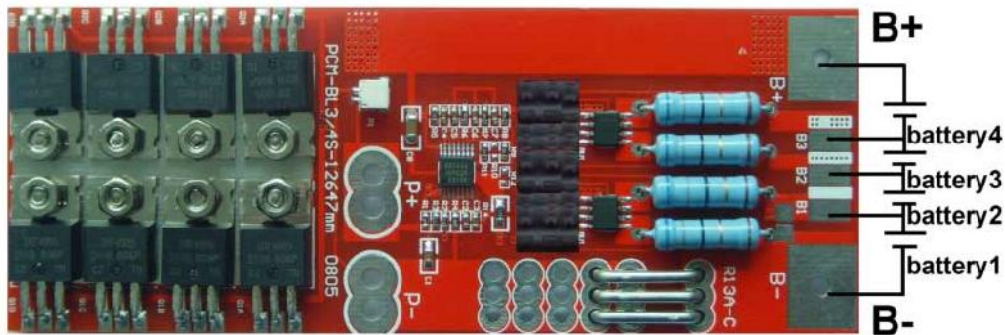

P+ = Charge+/Discharge+ P- = Charge-/Discharge-

Module wiring to the battery cells:

- connect **4 pieces of LiFePO4 cells** in series
- **B-** clamp on the module connect to the “-” **terminal** of the first battery cell
- **B1** clamp connect to the “+” **terminal** of the same first battery cell
- **B2** clamp to the “+” **terminal** on the second cell
- **B3** clamp to the “+” **terminal** on the third cell
- **B+** clamp connected to the “+” **terminal** of the fourth cell.
- **P+ and P-** clamps connect to the appliance **load**

Please refer also to the overall scheme, according to the last page of this PDF document. In particular, it is necessary to install a fuse in the circuit. Please note that scheme is universal as possible example for installation, it is always necessary to carefully design a project. GWL Power Company is not responsible for the specific involvement.

SBM04/60 Board 4cells (12V/60A)

Model name	SBM 04/60	
		4 cells (12V/60A)
Voltage	Charging voltage	C:14,4V 3.6V/Cell
	Balance voltage for single cell	3.6V±0.003V
Current	Balance current for single cell	72±10mA
	Current consumption for single cell	≤20µA
	Max. continuous current	60A
Overcharge Protection	Over charge detection voltage	3.90V±0.025V
	Over charge detection delay time	0.96S~1.4S
	Over charge release voltage	3.80±0.025V
Over-discharge Protection	Over discharge detection voltage	2.0±0.05V
	Over discharge detection delay time	115~173mS
	Over discharge release voltage	2.3±0.05V
Over Current Protection	Over current detection voltage	0.62V
	Over current detection current	200±30A
	Detection delay time	7.2ms~11ms
	Release condition	Automatic Recovery
Short Protection	Detection condition	Exterior short circuit
	Detection delay time	200-500µs
	Release condition	Automatic Recovery
Resistance	Protection circuitry	≤20mΩ
Temperature	Operating temperature range	-40 +85°C
	Storage temperature range	-40 +125°C
Dimensions	L * W * T	120 * 80 * 30mm
Weight	100g	Grams (tolerance +/- 2g)

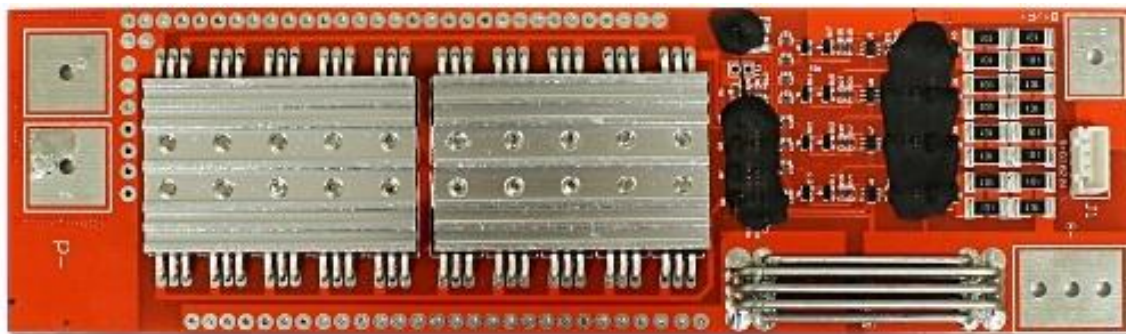

Module wiring to the battery cells:

- connect **4 pieces of LiFePO4 cells** in series
- **B-** clamp on the module connect to the “-” **terminal** of the first battery cell
- **B1** clamp connect to the “+” **terminal** of the same first battery cell
- **B2** clamp to the “+” **terminal** on the second cell
- **B3** clamp to the “+” **terminal** on the third cell
- **B4 and B+** clamps connected to the “+” **terminal** of the fourth cell. (two separate wires)
- **P+ and P-** clamps connect to the appliance **load**

Please refer also to the overall scheme, according to the last page of this PDF document.

In particular, it is necessary to install a fuse in the circuit. Please note that scheme is universal as possible example for installation, it is always necessary to carefully design a project.

GWL Power Company is not responsible for the specific involvement.

SBM08/10 Board 8cells (24V/10A)



Model name	SBM 08/10	GWL/Power Simple Battery Management Board 8 cells (24V/10A)
Voltage	Charging voltage	C:28,8V 3.6V/Cell
	Balance voltage for single cell	3.6V±0.025V
Current	Balance current for single cell	72±5mA
	Current consumption for single cell	≤20µA
	Max. continuous current	10A
Overcharge Protection	Over charge detection voltage	3.90V±0.025V
	Over charge detection delay time	0.96S~1.4S
	Over charge release voltage	3.80±0.025V
Over-discharge Protection	Over discharge detection voltage	2.0±0.05V
	Over discharge detection delay time	115~173mS
	Over discharge release voltage	2.3±0.05V
Over Current Protection	Over current detection voltage	0.62V
	Over current detection current	65±5A
	Detection delay time	7.2ms~11ms
	Release condition	Automatic Recovery
Short Protection	Detection condition	Exterior short circuit
	Detection delay time	200-500µs
	Release condition	Automatic Recovery
Resistance	Protection circuitry	≤20mΩ
Temperature	Operating temperature range	-40 +85°C
	Storage temperature range	-40 +125°C
Dimensions	L * W * T	148 * 65 * 9mm
Weight	100g	Grams (tolerance +/- 2g)

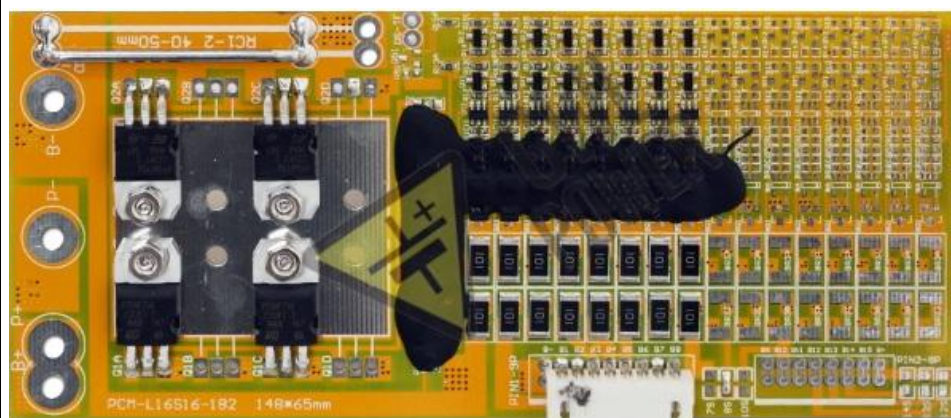

Module wiring to the battery cells:

- connect **8 pieces of LiFePO4 cells** in series
- **B-** clamp on the module connect to the “-” **terminal** of the first battery cell
- **B1** clamp connect to the “+” **terminal** of the same first battery cell
- **B2** clamp to the “+” **terminal** on the second cell
-
- **B7** clamp to the “+” **terminal** on the seventh cell
- **B8 and B+** clamps connected to the “+” **terminal** of the eighth cell. (two separate wires)
- **P+ and P-** clamps connect to the appliance **load**

Please refer also to the overall scheme, according to the last page of this PDF document. In particular, it is necessary to install a fuse in the circuit. Please note that scheme is universal as possible example for installation, it is always necessary to carefully design a project. GWL Power Company is not responsible for the specific involvement.

SBM08/40H Board 8cells (24V/40A)



Model name	SBM 08/40H	GWL/Power Simple Battery Management Board 8 cells (24V/40A)
Voltage	Charging voltage	C:28,8V 3.6V/Cell
	Balance voltage for single cell	3.6V±0.03V
Current	Balance current for single cell	180±10mA
	Current consumption for single cell	≤200µA
	Max. continuous current	40A
Overcharge Protection	Over charge detection voltage	3.90V±0.025V
	Over charge detection delay time	0.96S~1.4S
	Over charge release voltage	3.80±0.025V
Over-discharge Protection	Over discharge detection voltage	2.0±0.05V
	Over discharge detection delay time	115~173ms
	Over discharge release voltage	2.3±0.05V
Over Current Protection	Over current detection voltage	0.62V
	Over current detection current	150±20A
	Detection delay time	7.2ms~11ms
	Release condition	Cut load
Short Protection	Detection condition	Exterior short circuit
	Detection delay time	200-500µs
	Release condition	Cut load
Resistance	Protection circuitry	≤20mΩ
Temperature	Operating temperature range	-40 +85°C
	Storage temperature range	-40 +125°C
Dimensions	L * W * T	165 * 103 * 23 mm
Weight	300g	Grams (tolerance +/- 2g)

P+,P- = Charge+/-,Discharge+/-

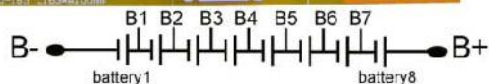
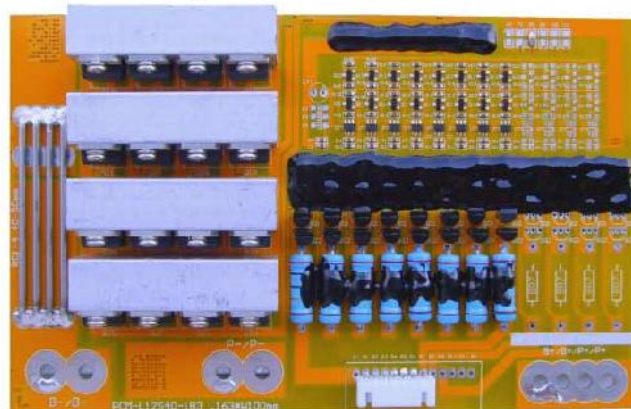

Module wiring to the battery cells:

- connect **8 pieces of LiFePO4 cells** in series
- **B-** clamp on the module connect to the “-” **terminal** of the first battery cell
- **B1** clamp connect to the “+” **terminal** of the same first battery cell
- **B2** clamp to the “+” **terminal** on the second cell
-
- **B7** clamp to the “+” **terminal** on the seventh cell
- **B8 and B+** clamps connected to the “+” **terminal** of the eighth cell. (two separate wires)
- **P+ and P-** clamps connect to the appliance **load**

Please refer also to the overall scheme, according to the last page of this PDF document. In particular, it is necessary to install a fuse in the circuit. Please note that scheme is universal as possible example for installation, it is always necessary to carefully design a project. GWL Power Company is not responsible for the specific involvement.

SBM08/60 Board 8cells (24V/60A)



Model name	SBM 08 / 60	GWL/Power Simple Battery Management Board 8 cells (24V/60A)
Voltage	Charging voltage	C:28,8V 3.6V/Cell
	Balance voltage for single cell	3.6V±0.003V
Current	Balance current for single cell	72±10mA
	Current consumption for single cell	≤20µA
	Max. continuous current	60A
Overcharge Protection	Over charge detection voltage	3.90V±0.025V
	Over charge detection delay time	0.96S~1.4S
	Over charge release voltage	3.80±0.025V
Over-discharge Protection	Over discharge detection voltage	2.0±0.05V
	Over discharge detection delay time	115~173ms
	Over discharge release voltage	2.3±0.05V
Over Current Protection	Over current detection voltage	0.62V
	Over current detection current	200±30A
	Detection delay time	7.2ms~11ms
	Release condition	Automatic Recovery
Short Protection	Detection condition	Exterior short circuit
	Detection delay time	200-500µs
	Release condition	Automatic Recovery
Resistance	Protection circuitry	≤20mΩ
Temperature	Operating temperature range	-40 +85°C
	Storage temperature range	-40 +125°C
Dimensions	L * W * T	120 * 80 * 30mm
Weight	220g	Grams (tolerance +/- 2g)

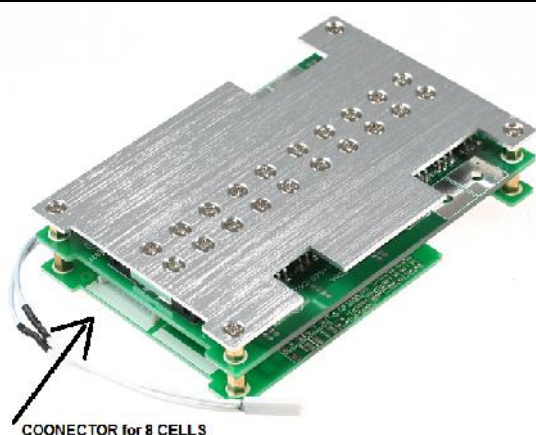

CONNECTOR for 8 CELLS

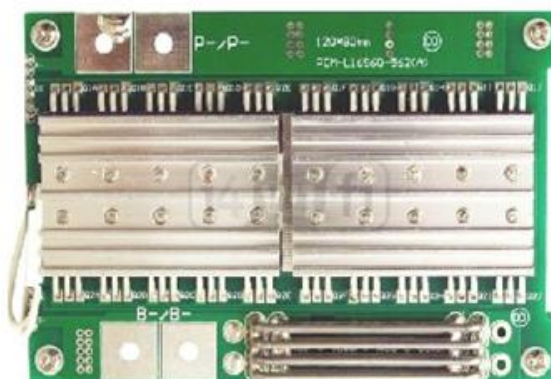

Module wiring to the battery cells:

- connect **8 pieces of LiFePO4 cells** in series
- **B-** clamp on the module connect to the **"-" terminal** of the first battery cell
- **B1** clamp connect to the **"+" terminal** of the same first battery cell
- **B2** clamp to the **"+" terminal** on the second cell
-
- **B7** clamp to the **"+" terminal** on the seventh cell
- **B8** clamp connect to the **"+" terminal** of the eighth cell.
- This **"+" terminal** of the last cell connect to **"+" input** of Appliance
- **P-** clamp connect to the **"-" input** of Appliance **load**

Please refer also to the overall scheme, according to the last page of this PDF document. In particular, it is necessary to install a fuse in the circuit. Please note that scheme is universal as possible example for installation, it is always necessary to carefully design a project. GWL Power Company is not responsible for the specific involvement.

SBM12/10 Board 12cells (36V/10A)



Model name	SBM12/10	GWL/Power Simple Battery Management Board 12 cells (36V/10A)
Voltage	Charging voltage	C:43,2V 3.6V/Cell
	Balance voltage for single cell	3.6V±0.025V
Current	Balance current for single cell	72±5mA
	Current consumption for single cell	≤20µA
	Max. continuous current	10A
Overcharge Protection	Over charge detection voltage	3.90V±0.025V
	Over charge detection delay time	0.96S~1.4S
	Over charge release voltage	3.80±0.025V
Over-discharge Protection	Over discharge detection voltage	2.0±0.05V
	Over discharge detection delay time	115~173mS
	Over discharge release voltage	2.3±0.05V
Over Current Protection	Over current detection voltage	0.62V
	Over current detection current	65±5A
	Detection delay time	7.2ms~11ms
	Release condition	Automatic Recovery
Short Protection	Detection condition	Exterior short circuit
	Detection delay time	200-500µs
	Release condition	Automatic Recovery
Resistance	Protection circuitry	≤20mΩ
Temperature	Operating temperature range	-40 +85°C
	Storage temperature range	-40 +125°C
Dimensions	L * W * T	148 * 65 * 9mm
Weight	100g	Grams (tolerance +/- 2g)

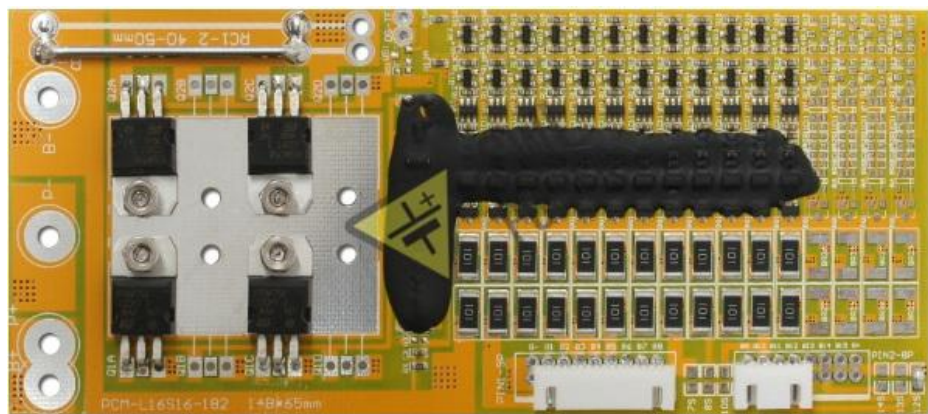

Module wiring to the battery cells:

- connect **12 pieces of LiFePO4 cells** in series
- **B-** clamp on the module connect to the “-” **terminal** of the first battery cell
- **B1** clamp connect to the “+” **terminal** of the same first battery cell
- **B2** clamp to the “+” **terminal** on the second cell
-
- **B11** clamp to the “+” **terminal** on the eleventh cell
- **B12 and B+** clamps connected to the “+” **terminal** of the twelfth cell. (two separate wires)
- **P+ and P-** clamps connect to the appliance **load**

Please refer also to the overall scheme, according to the last page of this PDF document. In particular, it is necessary to install a fuse in the circuit. Please note that scheme is universal as possible example for installation, it is always necessary to carefully design a project. GWL Power Company is not responsible for the specific involvement.

SBM12/60 Board 12cells (36V/60A)



Model name	SBM12/60	GWL/Power Simple Battery Management Board 12 cells (36V/60A)
Voltage	Charging voltage	C:43,2V 3.6V/Cell
	Balance voltage for single cell	3.6V±0.003V
Current	Balance current for single cell	72±10mA
	Current consumption for single cell	≤20µA
	Max. continuous current	60A
Overcharge Protection	Over charge detection voltage	3.90V±0.025V
	Over charge detection delay time	0.96S~1.4S
	Over charge release voltage	3.80±0.025V
Over-discharge Protection	Over discharge detection voltage	2.0±0.05V
	Over discharge detection delay time	115~173mS
	Over discharge release voltage	2.3±0.05V
Over Current Protection	Over current detection voltage	0.62V
	Over current detection current	200±30A
	Detection delay time	7.2ms~11ms
	Release condition	Automatic Recovery
Short Protection	Detection condition	Exterior short circuit
	Detection delay time	200-500µs
	Release condition	Automatic Recovery
Resistance	Protection circuitry	≤20mΩ
Temperature	Operating temperature range	-40 +85°C
	Storage temperature range	-40 +125°
Dimensions	L * W * T	120 * 80 * 30mm
Weight	120g	Grams (tolerance +/- 2g)

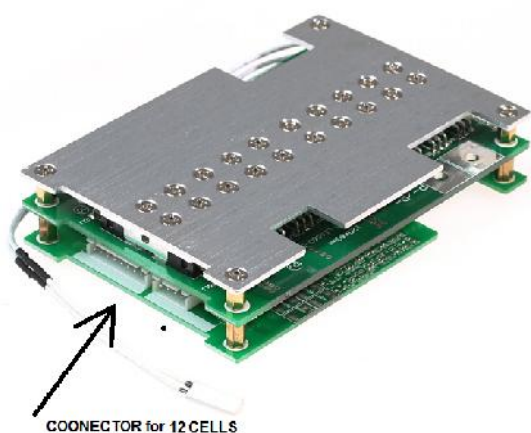

CONNECTOR for 12 CELLS



Module wiring to the battery cells:

- connect **12 pieces of LiFePO4 cells** in series
- **B-** clamp on the module connect to the “-” **terminal** of the first battery cell
- **B1** clamp connect to the “+” **terminal** of the same first battery cell
- **B2** clamp to the “+” **terminal** on the second cell
-
- **B11** clamp to the “+” **terminal** on the eleventh cell
- **B12** clamp connect to the “+” **terminal** of the twelfth cell.
- This “+” **terminal** of the last cell connect to “+” **input** of Appliance
- **P-** clamp connect to the “-” **input** of Appliance **load**

Please refer also to the overall scheme, according to the last page of this PDF document. In particular, it is necessary to install a fuse in the circuit. Please note that scheme is universal as possible example for installation, it is always necessary to carefully design a project. GWL Power Company is not responsible for the specific involvement.

SBM Board 16 cells (48V/10A)



Model name	SBM 16 / 10A2	GWL/Power Simple Battery Management Board 16 cells (48V/10A)
Voltage	Charging voltage	C:57.6V 3.6V/Cell
	Balance voltage for single cell	3.6V±0.05V
Current	Balance current for single cell	72±10mA
	Current consumption for single cell	≤20µA
	Max. continuous current	10A
Overcharge Protection	Over charge detection voltage	3.90V±0.05V
	Over charge detection delay time	0.5S~2S
	Over charge release voltage	3.80±0.1V
Over-discharge Protection	Over discharge detection voltage	2.0±0.1V
	Over discharge detection delay time	50mS~200mS
	Over discharge release voltage	2.3±0.1V
Over Current Protection	Over current detection current	50±10A
	Detection delay time	5ms~60ms
	Release condition	Cut load
Short Protection	Detection condition	Exterior short circuit
	Detection delay time	200-800µs
	Release condition	Cut Load
Resistance	Protection circuitry	≤20mΩ
Temperature	Operating temperature range	-40 +85°C
	Storage temperature range	-40 +125°C
Dimensions	L * W * T	78 * 47 * 18mm
Weight	0,220 kg	Kilograms (tolerance +/- 2g)

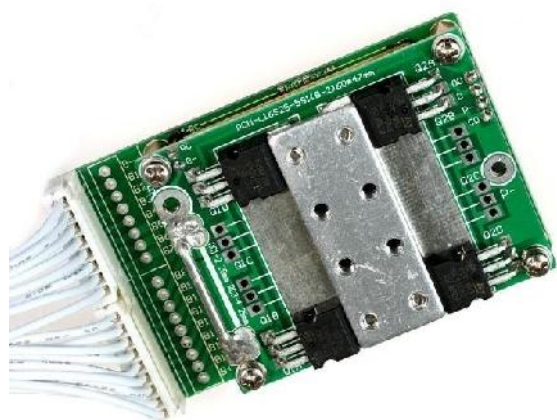

Module wiring to the battery cells:

- connect **16 pieces of LiFePO4 cells** in series
- **B-** clamp on the module connect to the “-” **terminal** of the first battery cell
Please note, that must lead two separate wires, one for a little first pin on the input connector and the second wire (stronger) to the large clamp on SBM module.
- **B1** clamp connect to the “+” **terminal** of the same first battery cell
- **B2** clamp to the “+” **terminal** on the second cell
-
- **B15** clamp to the “+” **terminal** on the fifteenth cell
- **B16 and B+** clamps connected to the “+” **terminal** of the sixteenth cell. (two separate wires)
- **P+ and P-** clamps connect to the appliance **load**

Please refer also to the overall scheme, according to the last page of this PDF document. In particular, it is necessary to install a fuse in the circuit. Please note that scheme is universal as possible example for installation, it is always necessary to carefully design a project. GWL Power Company is not responsible for the specific involvement.

SBM16/60 Board 16 cells (48V/60A)



Model name	SBM16/60	GWL/Power Simple Battery Management Board 16 cells (48V/60A)
Voltage	Charging voltage	C:57.6V 3.6V/Cell
	Balance voltage for single cell	3.6V±0.003V
Current	Balance current for single cell	72±10mA
	Current consumption for single cell	≤20µA
	Max. continuous current	60A
Overcharge Protection	Over charge detection voltage	3.90V±0.025V
	Over charge detection delay time	0.96S~1.4S
	Over charge release voltage	3.80±0.025V
Over-discharge Protection	Over discharge detection voltage	2.0±0.05V
	Over discharge detection delay time	115~173mS
	Over discharge release voltage	2.3±0.05V
Over Current Protection	Over current detection voltage	0.62V
	Over current detection current	200±30A
	Detection delay time	7.2ms~11ms
	Release condition	Automatic Recovery
Short Protection	Detection condition	Exterior short circuit
	Detection delay time	200-500µs
	Release condition	Automatic Recovery
Resistance	Protection circuitry	≤20mΩ
Temperature	Operating temperature range	-40 +85°C
	Storage temperature range	-40 +125°C
Dimensions	L * W * T	120 * 80 * 30mm
Weight	220g	Grams (tolerance +/- 2g)

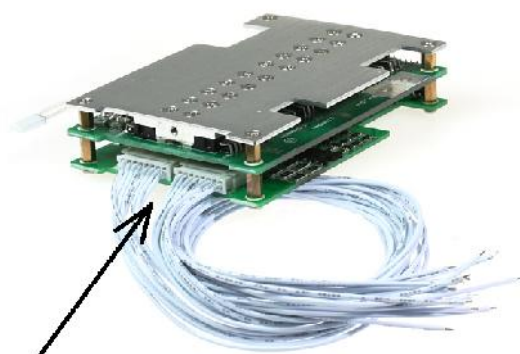

CONNECTOR for 16 CELLS

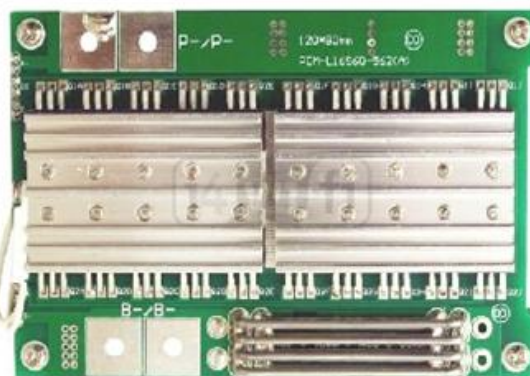

Module wiring to the battery cells:

- connect **16 pieces of LiFePO4 cells** in series
- **B-** clamp on the module connect to the “-” **terminal** of the first battery cell
- **B1** clamp connect to the “+” **terminal** of the same first battery cell
- **B2** clamp to the “+” **terminal** on the second cell
-
- **B15** clamp to the “+” **terminal** on the fifteenth cell
- **B16** clamp connect to the “+” **terminal** of the sixteenth cell.
- This “+” **terminal** of the last cell connect to “+” **input** of Appliance
- **P-** clamp connect to the “-” **input** of Appliance **load**

Please refer also to the overall scheme, according to the last page of this PDF document. In particular, it is necessary to install a fuse in the circuit. Please note that scheme is universal as possible example for installation, it is always necessary to carefully design a project. GWL Power Company is not responsible for the specific involvement.

Wiring diagram for SBM16/60

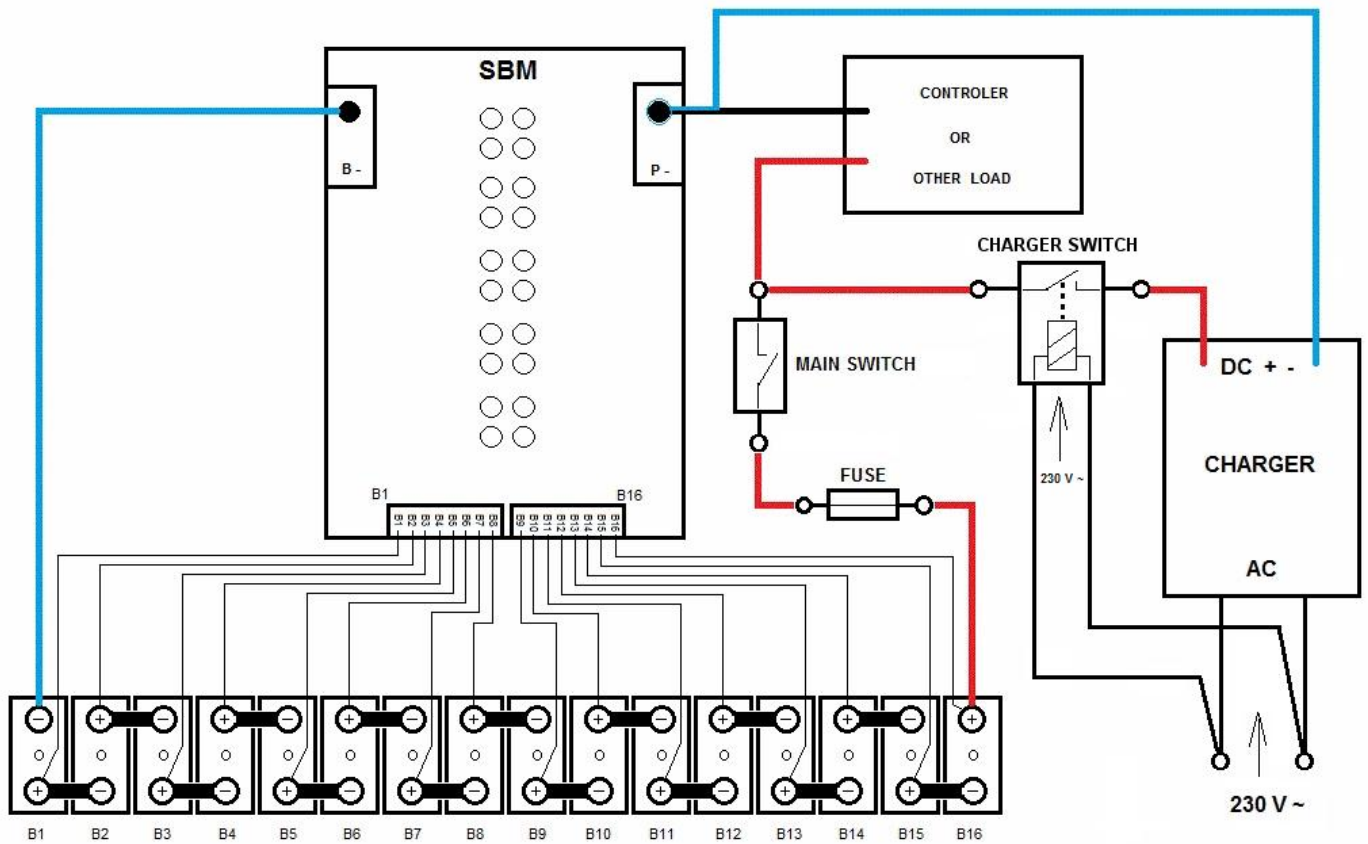

PLEASE NOTE:

This schema is applicable to every SBM modules with difference in number of monitored cells.

Only certain number of cells can be used for certain version of SBM. I.e. SBM16/60 is only for 16 cells, etc.

SBM24/40 Board 24 cells 72V/40A)



Model name	SBM24/40	GWL/Power Simple Battery Management Board 24 cells (72V/40A)
Voltage	Charging voltage	C:86.4V 3.6V/Cell
	Balance voltage for single cell	3.6V±0.025V
Current	Balance current for single cell	72±10mA
	Current consumption for single cell	≤20µA
	Max. continuous current	40A
Overcharge Protection	Over charge detection voltage	3.90V±0.025V
	Over charge detection delay time	0.5S~2S
	Over charge release voltage	3.80±0.05V
Over-discharge Protection	Over discharge detection voltage	2.0±0.062V
	Over discharge detection delay time	10~300mS
	Over discharge release voltage	2.0±0.062V
Over Current Protection	Over current detection voltage	0.1±°0.020V
	Over current detection current	150±20A
	Detection delay time	5ms~20ms
	Release condition	Cut Load
Short Protection	Detection condition	Exterior short circuit
	Detection delay time	200-500µs
	Release condition	Charge release
Resistance	Protection circuitry	≤20mΩ
Temperature	Operating temperature range	-40 +85°C
	Storage temperature range	-40 +125°C
Dimensions	L * W * T	115 * 75 * 30mm
Weight	220g	Grams (tolerance +/- 2g)

P+=B+=Charge+/Discharge+

P- =Charge-/Discharge-

Size:L115*W75mm

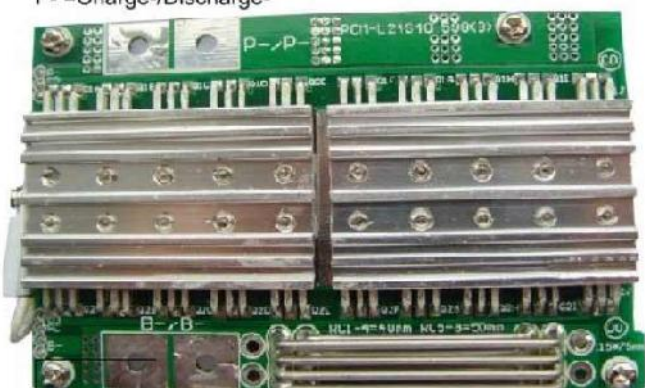

B- B1 B2 B3 B4 B5 B6 B7 B8 B9 B10 B11 B12 B13 B14 B15 B16 B17 B18 B19 B20 B21 B22 B23 B24/B+

- connect **24 pieces of LiFePO4 cells** in series
- **B-** clamp on the module connect to the “-” **terminal** of the first battery cell
- **B1** clamp connect to the “+” **terminal** of the same first battery cell
- **B2** clamp to the “+” **terminal** on the second cell
-
- **B23** clamp to the “+” **terminal** on the twenty-third cell
- **B24** clamp connect to the “+” **terminal** of the twenty-fourth cell
- This “+” **terminal** of the last cell connect to “+” **input** of Appliance
- **P-** clamp connect to the “-” **input** of Appliance **load**

Please refer also to the overall scheme, according to the last page of this PDF document. In particular, it is necessary to install a fuse in the circuit. Please note that scheme is universal as possible example for installation, it is always necessary to carefully design a project. GWL Power Company is not responsible for the specific involvement.